

Designation:

Pre rinse spray unit COMFORT CLEAN
Single-hole mixer tap 1/2"
High pressure, stainless steel

Article number:

361-101/230-125

Description:



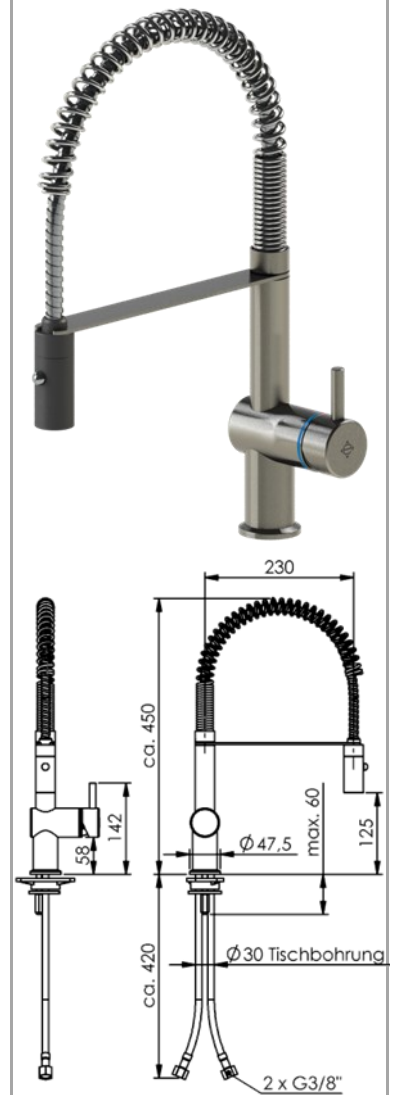

- Designed for high pressure only, operating pressure 1-6 bar
- Heat insulating handle, lateral
- Spray gun **Soft Touch** switches from normal to spray jet
- Projection of the spray gun P = 230 mm, height H = 125 mm, total height G = 450 mm
- Temperature and flow control with modern eco ceramic cartridge (2 stage water saving function)
- Flexible connection hoses 2 x 500 mm, union nut 3/8"
- Easy-to-install fastening system M8 x 140 mm for worktop thickness of up to approx. 50 mm
- Non-return valves prevents circulation between hot and cold water and suctioning of dirty water (2 pieces DW15/DN10, 3/8" female thread x 3/8" male thread) for mounting on angle valve
- Material **stainless steel**
- Hot water resistant up to 80°C
- Worktop bore hole Ø30 mm

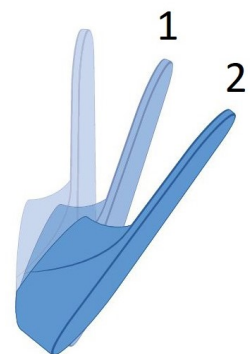
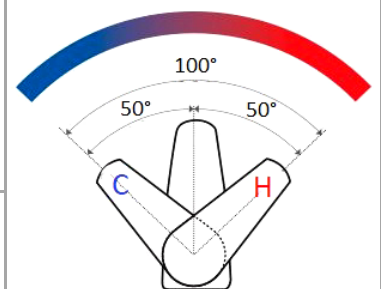
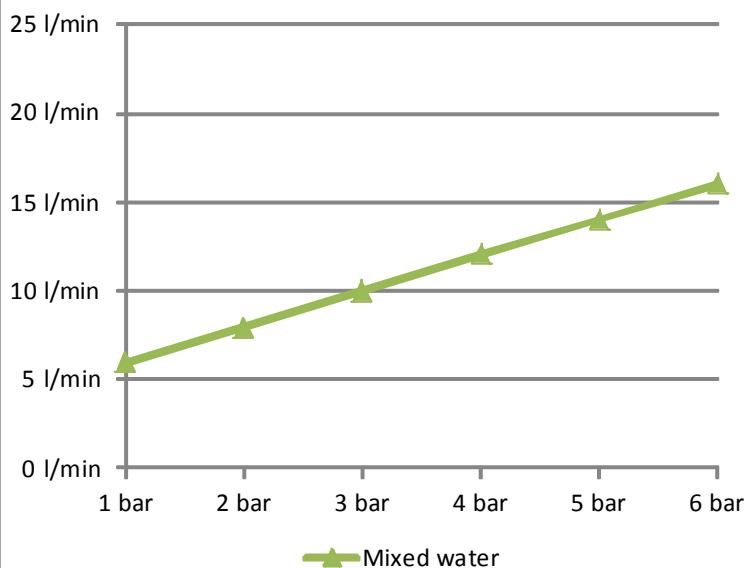

Flow rate:



2 stage eco cartridge with water saving function

| | | |
|--------------------------|--|---|
| <p>Proper use:</p> | <p>The pre rinse spray unit is used in commercial kitchens. The fitting must only be operated by trained specialist staff with a minimum age of 14 years.</p> <p>Assembly and disassembly may only be carried out by certified specialist tradesmen.</p> |  |
| <p>Improper use:</p> | <p>The fitting is not suitable for connection to low-pressure hot water boilers.</p> <p>The fitting must not be used to clean push-through dishwashers. There is a risk of damage to the hose from excessive pulling.</p> |  |
| <p>Hazard warning:</p> | <p>In case of disassembly or repair the angle valves should be shut off.</p> <p>In order to prevent water damage, the mixer tap has to be closed outside business hours.</p> |  |
| <p>Care instruction:</p> | <p>Do not use cleaning agents with a high chlorine or acid content. Refrain from using high-pressure cleaning devices, as defined in work sheet VdF 018, for instance.</p> <p>No types of scouring agents are to be used for cleaning purposes as they scratch the surface.</p> |  |
| <p>Admissions:</p> | <p>All seals meet the requirements for plastics in contact with water and the requirements of DVGW work sheet W 270.</p> |  |
| <p>Manufacturer:</p> | <p>Gebr. Echtermann GmbH & Co.KG P.O. Box 1456 D 58584 Iserlohn</p> <p>Tel: +49 (0) 2371 / 9582-0 Fax: +49 (0) 2371 / 52787 Email: contact@echtermann.de</p> | |