

Designation:

Double swivel valve 3/4"
Stainless steel

Article number:

221-101/400+350-550
221-101/400+350-350



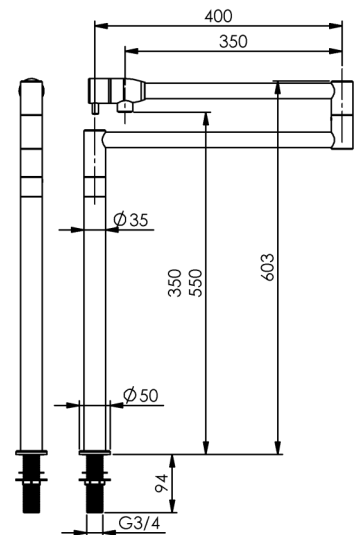

Description:

- Designed for high pressure only, operating pressure 1-6 bar
- Valve at spout (no additional valve block necessary)
- Double swivel spout with JetSafe (drip stop), 360° pivotable
- Projection A = 400 mm + 350 mm
- Height under spout H = 550 mm / 350 mm
- Easy-to-install fastening system with fastening nut and nozzle with G 3/4" x 94 mm
- Material **stainless steel**
- Hot water resistant up to 80°C
- Worktop bore hole Ø27 mm

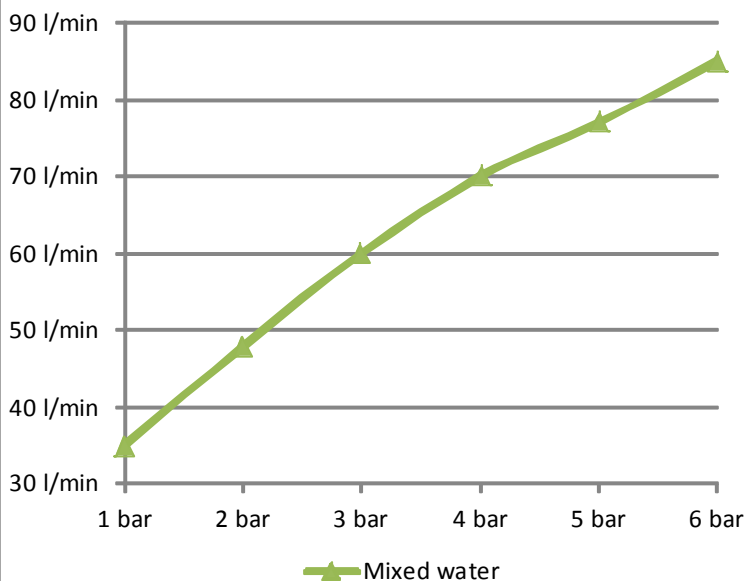

Flow rate:



<p>Proper use:</p>	<p>The pre rinse spray unit is used in commercial kitchens. The fitting must only be operated by trained specialist staff with a minimum age fo 14 years.</p> <p>Assembly or disassembly may only be carried out by certified specialist tradesmen.</p>	
<p>Improper use:</p>	<p>The fitting is not suitable for connection to high pressure systems.</p>	
<p>Hazard warning:</p>	<p>In case of diassembly or repair the angle valves should be shut off.</p>	
<p>Care instructions:</p>	<p>Do not use cleaning agents with a high chlorine or acid content. Refrain from using high-pressure cleaning devices, as defined in work sheet VdF 018, for instance.</p> <p>No types of scouring agents are to be used for cleaning purposes as they scratch the surface.</p>	
<p>Admissions:</p>	<p>All seals meet the requirements for plastics in contact with water and the requirements of DVGW work sheet W 270.</p>	
<p>Manufacturer:</p>	<p>Gebr. Echtermann GmbH & Co.KG P.O. Box 1456 D 58584 Iserlohn</p> <p>Tel: +49 (0) 2371 / 9582-0 Fax: +49 (0) 2371 / 52787 Email: contact@echtermann.de</p>	